

Probes with thread connection



AFNOR NF-S 90-116
probe, thread
ISO G. 1/4" F.



AFNOR NF-S 90-116
type EASYFIX® probe,
thread ISO G. 1/4" F.



UNI 9507 probe,
thread ISO G. 1/4" F.



BS 5682 probe,
thread ISO G. 1/4" F.



DIN 13260-2 probe,
thread ISO G. 1/4" F.



SS 875 24 30 probe,
thread ISO G. 1/4" F.



JIS T 7101 probe,
thread ISO G. 1/8" M.



SANS 1409 probe,
thread ISO G. 1/4" F.

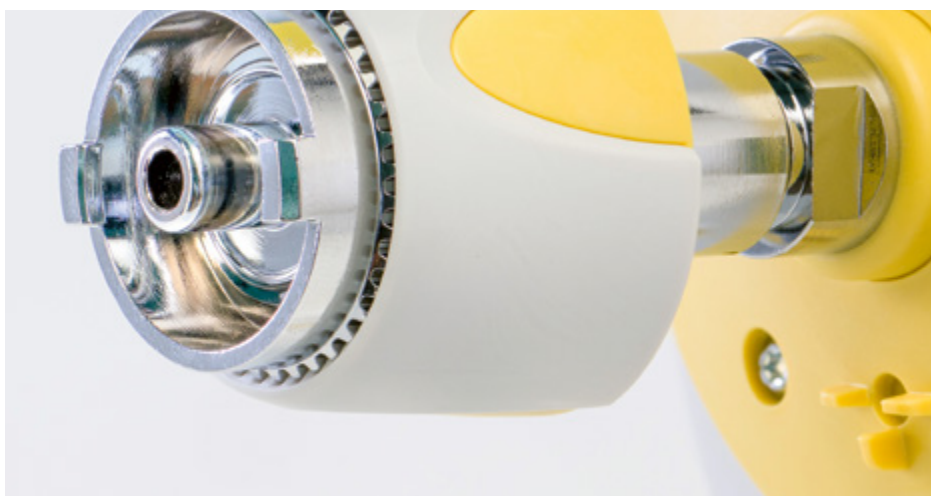

OHMEDA probe,
thread ISO G. 1/4" F.

Probes with hose connection

Vacuum regulator outlet hose connection · Stainless steel rail

Probes with hose connection



Vacuum regulator outlet hose connection

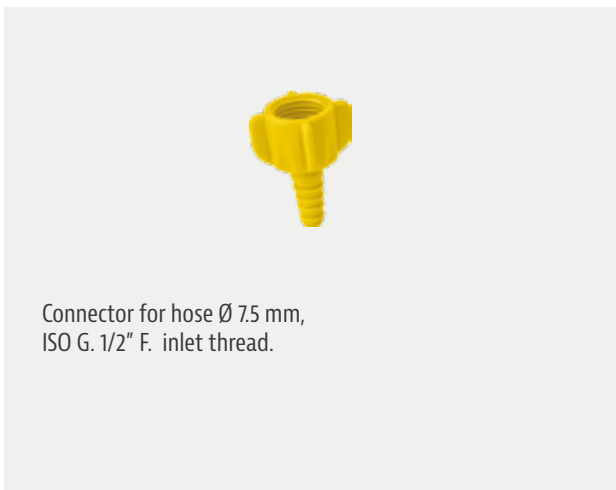

Stainless steel rail

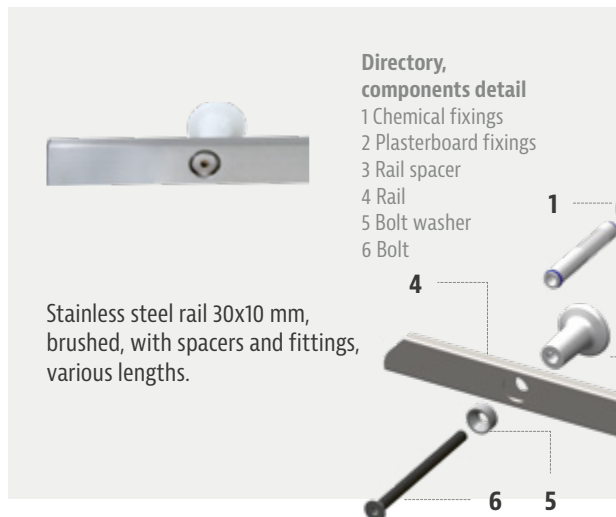

Rail clamping systems

Wall brackets · Catheter containers

Rail clamping systems



ABS clamp bracket for rail 30x10 mm and 50x10 mm, with nipple threaded ISO G. 1/4" F. and hose connector Ø 7.5 mm.



ABS clamp bracket for rail 30x10 mm and 50x10 mm, with slide 25x5 mm, 30x5 mm, 45x5 mm.

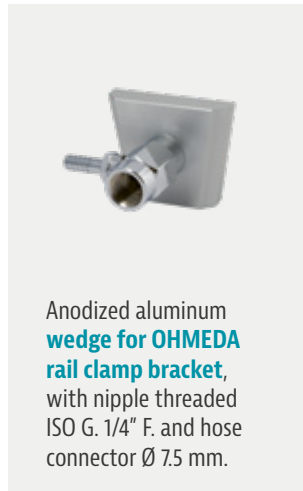

Anodized aluminum wedge for OHMEDA rail clamp bracket, with nipple threaded ISO G. 1/4" F. and hose connector Ø 7.5 mm.

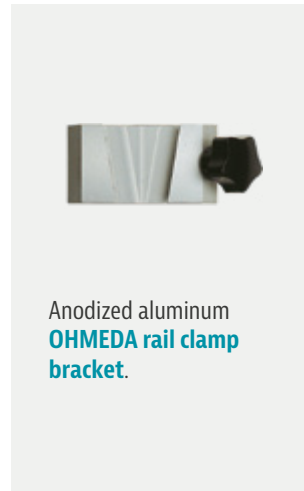

Anodized aluminum OHMEDA rail clamp bracket.

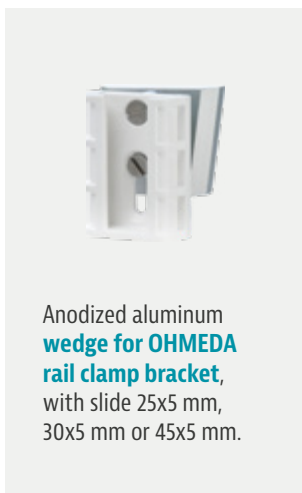

Anodized aluminum wedge for OHMEDA rail clamp bracket, with slide 25x5 mm, 30x5 mm or 45x5 mm.

Wall brackets

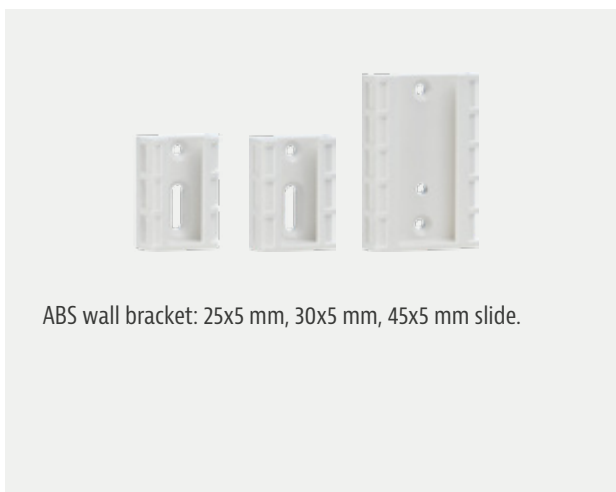

ABS wall bracket: 25x5 mm, 30x5 mm, 45x5 mm slide.

Catheter containers

flow-meter™ catheter containers are accessories allowing the operators to put down in a hygienic way the suction hose during their activity. They are made with tube of polycarbonate Ø 54 mm by 400 mm length, and they are fully autoclavable (121 °C - 15 min.).

Moreover these containers can be placed in a specific support ring for rail or trolley, in a single or twin construction.



Single and twin construction

Supporting devices for collection jars

The range of jars supporting devices includes trolleys, metallic support basket and ABS support rings for all containers sizes and models. Baskets and rings are manufactured with a strong and stiff hook matching with main slide sizes.



ABS support ring for **MAK/1000** jar, slides 25x5, 30x5, 41x4, 45x5 mm hook



ABS support ring for **MAK/2000** jars, slides 25x5, 30x5, 41x4, 45x5 mm hook



ABS support ring for **FLOVAC®** jars, slides 25x5, 30x5, 41x4, 45x5 mm hook



Metallic support basket for **MAK/4000** jar, slide 25x5 mm



Clip fixing 25x5 mm rings for trolleys, brackets and wall plates





5 wheels trolley up to 4 different jars (MAK and FLOVAC®) with vacuum gauge and 4 ON-OFF taps



5 wheels trolley up to 4 different jars (MAK and FLOVAC®) with handle



5 wheels trolley up to 4 different jars (MAK and FLOVAC®) with vacuum regulator and 4 ON-OFF taps



5 wheels trolley up to 4 different jars (MAK) and up to 12 jars (FLOVAC®) with vacuum regulator and safety jar EASYSAFE® and 4 ON-OFF taps

OXYGEN THERAPY
 SUCTION OF FLUIDS
 PRESSURE REGULATORS AND FLOWMETERS
 ALL MEDICAL GASES
 FLOWMETER UNITS
 TERMINAL UNITS
 ACCESSORIES